



UNIVERSITAT DE
BARCELONA

TUTORIAL 5: AERIAL MONITORING OF POLLUTION AND ODOURS IN INDUSTRIAL PLANTS

Agustín Gutierrez-Galvez
University of Barcelona & IBEC

ISOEN 2026

Outline

- Drone-based environmental chemical sensing
 - Introduction
 - Chemical instrumentation
 - Integration strategies
 - Tasks developed
 - Current limitations and future perspectives
- Chemical and Odour monitoring in industrial plants
 - The SNIFFIRDRONE project
 - Drone prototype
 - Custom multisensor system
 - Measuring campaigns
 - Odour prediction model
 - Static vs. dynamic calibration
 - Odour map
 - Conclusions



Small drones

- Definition
 - *Remotely piloted aircraft system (RPAS) or unmanned aircraft system (UAS) with a maximum take-off weight (MTOW) of <25 kg*
- Also known as ...
 - Microdrones or small UAS
- Two Types

(1) Fixed wings



(2) Rotary wings



Wide range of applications

- a) Volcanic research
- b) Landfill emission monitoring
- c) Chemical monitoring in industrial sites
- d) Early fire detection
- e) Residential emissions monitoring
- f) Ship emission monitoring
- g) Precision agriculture
- h) Urban air quality

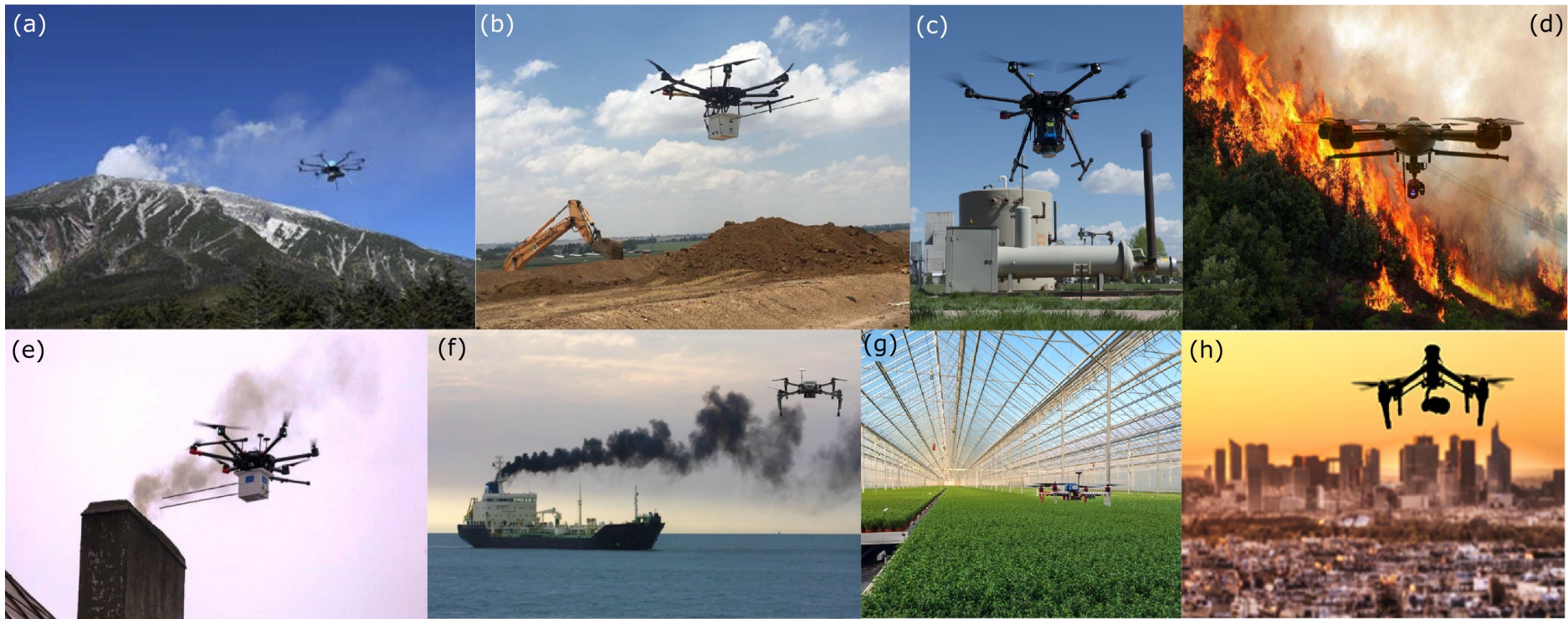

Chemical instrumentation

- Instrumentation constraints
 - Light weigh
 - Low power consumption
- Several sensing element types are commonly used
 - Low cost chemical sensors
 - Electrochemical, Metal Oxide, NDIR, PID
 - High precision optical analysers
 - Optical gas imaging
- Chemical instruments
 - Multi-sensor system
 - Electronic nose



Low cost chemical sensors

- **Electrochemical sensors**

- Electrochemical reaction within an electrochemical cell
- Selectivity controlled by the catalyst
- O₂, CO, SO₂, NO, NO₂, O₃, NH₃, and H₂S
- PPMs and PPBs concentrations
- Consumption < **1mW**
- Response / recovery times
 - > **30 - 60 s**



- **Metal Oxide (MOX) sensors**

- Chemoresistive sensors
- Few mm² footprint
- Response time 5-10s
- Consumption 15-30 mW
- Broad selective, but tunable sensitivity

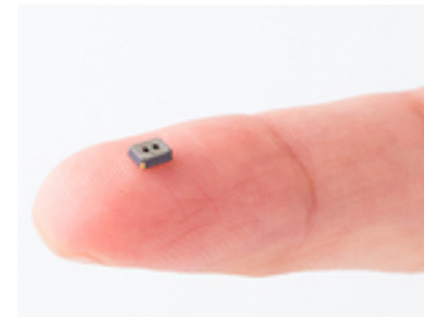

Low cost chemical sensors

- **Non-dispersive Infrared (NDIR)**

- Miniaturized Optical analyzers
- Based on optical absorption on IR band
- Cross-sensitivity to temperature and humidity limits accuracy
- As a physical sensor, it avoids poisoning and inter-device variability
- Power consumption 50mW
- Well suited for CO₂



- **Photo ionization detectors (PIDs)**

- Broad band sensors
- Based on UV light ionization of gases
- Wide range of VOC and some inorganic gases
- From 10 ppb to 10,000 ppm
- Very low response time of even a few ms
- Cannot detect compounds with high ionization energy (CO, CO₂, SO₂)



High precision optical analyzers

- Optical analyzers based on IR or UV absorption
- Composed of
 - IR source
 - Optical path
 - IR detector
 - Fluidic system
- Detects
 - CO₂ and CH₄ in mid-IR
 - O₃ in the near-UV
- Faster than chemical reactions based sensors
- Weights 1,3 Kg
- Power consumption 5 W

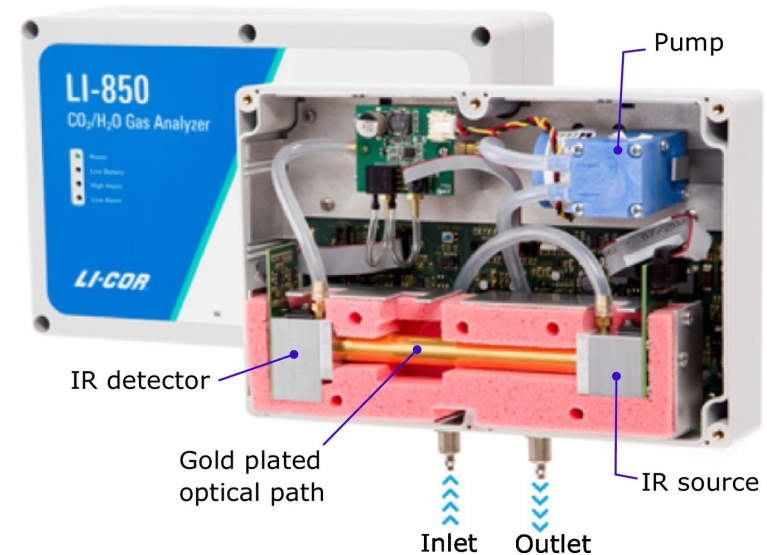

Closed-path LI-850 NDIR CO₂ analyzer

High precision optical analyzers

- **Laser absorption spectroscopy (LAS)**
 - Most common technique tunable diode LAS (TDLAS)
- Two types according to optical path
 - Closed path
 - > More accurate but slower
 - > Closed path Tunable Diode Laser (CP-TDL)
 - > Off-axis integrated cavity output spectroscopy (OA-ICOS)
 - Open path
 - > Open path Tunable Diode Laser (CP-TDL)

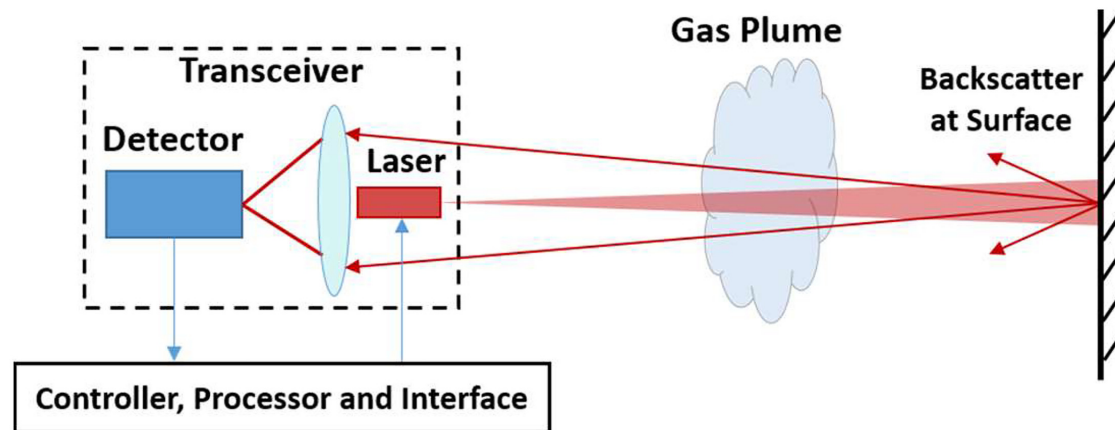

Optical gas imaging (OGI)

- Thermal contrast between background and gas
- Based on an IR or thermal camera with optical filter
- Shortcomings
 - High cost
 - Difficult to quantify leak rate
 - High detection limit - 10,000 ppm



Multi-sensor systems

- Need to monitor more than one gas in environmental applications
 - Include sensors to target different gases
 - Even different sensor technologies
- Also usually integrates...
 - Necessary electronics
 - Data logging
 - Sensor chamber
 - Fluidic delivery system
 - Communications
 - > GPS, radio link



Sniffer 4D equipped with 5 Electrochemical sensors, 1 PID and 1 NDIR sensor.

Integration strategies (1/3)

Protruding boom

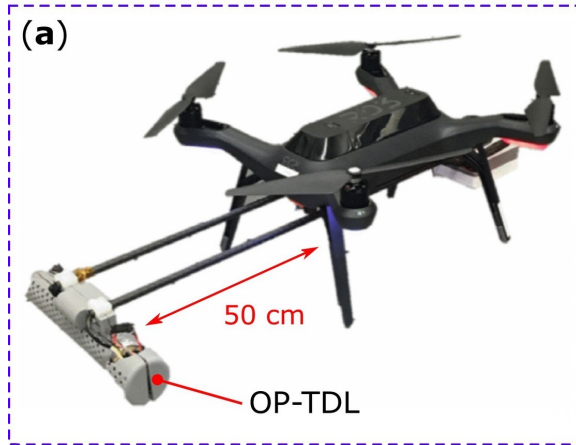

Pumped systems with horizontal/vertical inlet

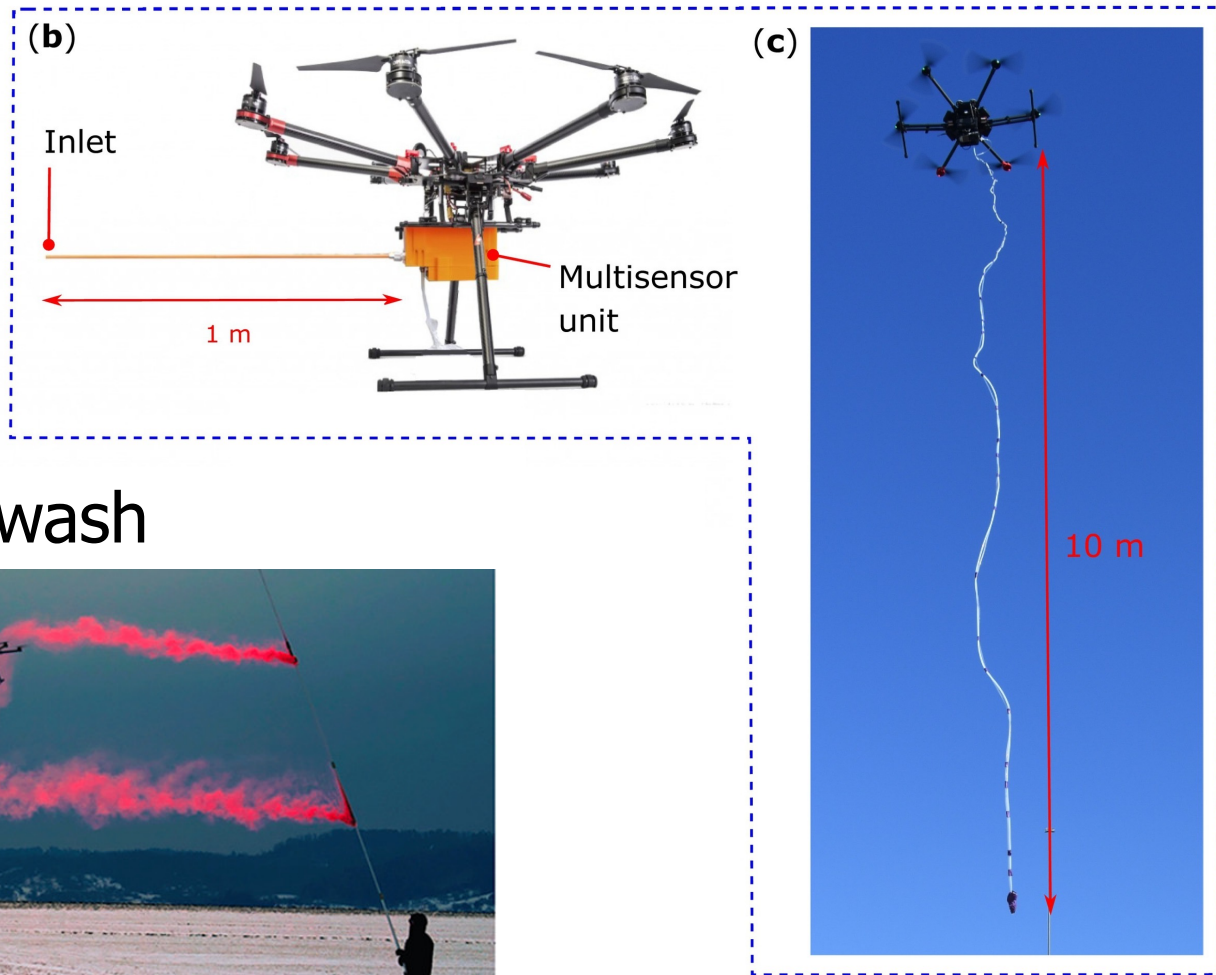

Downwash



Integration strategies (2/3)

Bottom mount

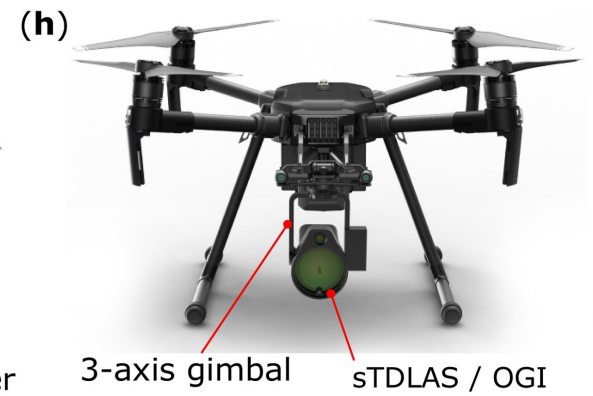
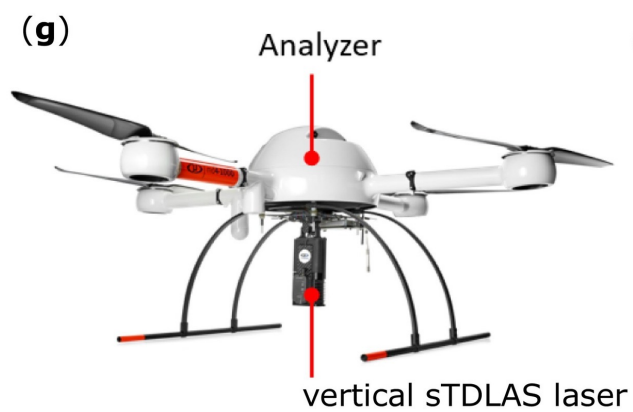
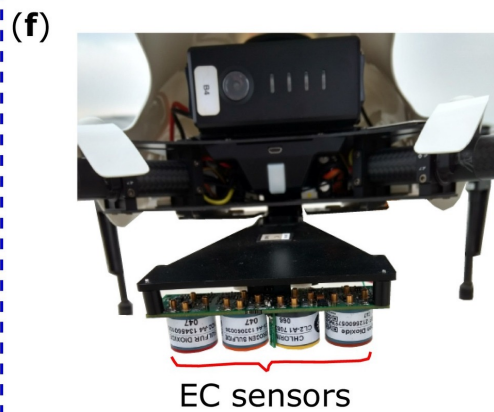
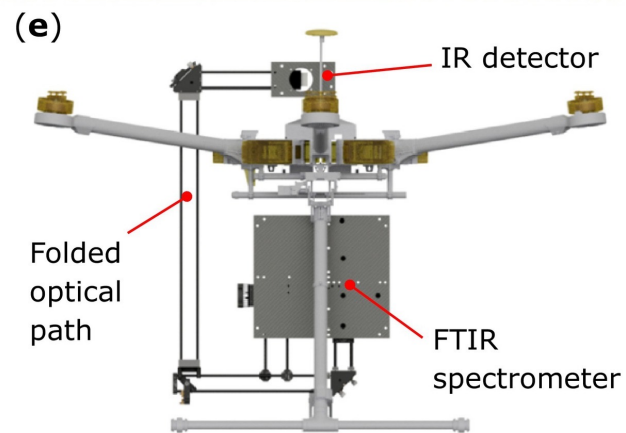
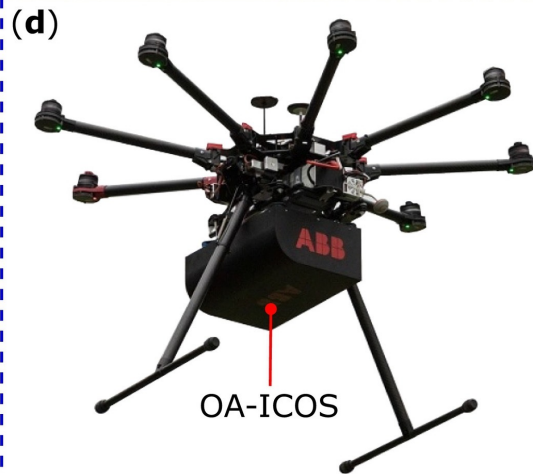

Integration strategies (3/3)

Top mount

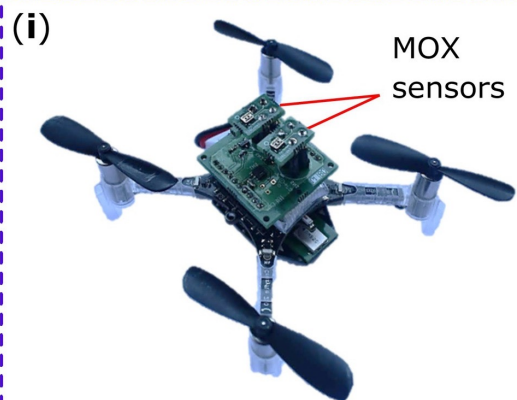

Frontal mount

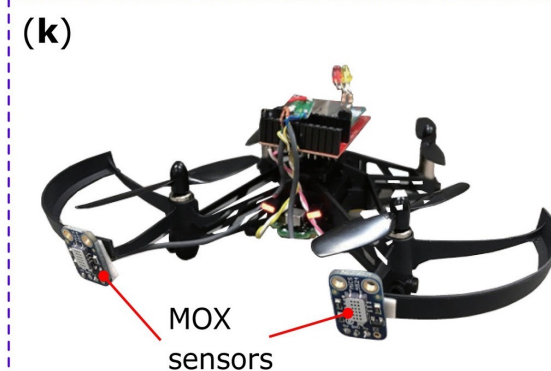

Tasks developed by chemical sensing drones (1/2)

- **Gas concentration mapping**

- Building spatial representations of gas concentrations
- The drone follows a predefined navigation path
- Map reconstruction based on spatial interpolation
 - > Gaussian kernels
 - > Polynomial

25 m × 25 m concentration map
Equidistant grid points
DJI Matrice 100 with a PID sensor
Flying at constant height

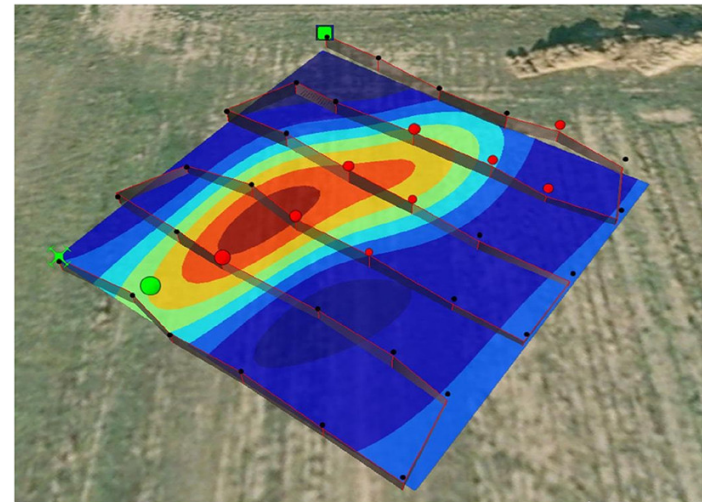

Tasks developed by chemical sensing drones (2/2)

- **Gas source localization**

- Find the source based on chemical cues on the environment
- Application
 - > Finding gas leaks
 - > Finding mal odour sources
- Many GSL algorithms have been proposed
 - > Reactive plume tracking

- **Gas source identification**

- Deciding whether a candidate source is currently emitting a chemical or not

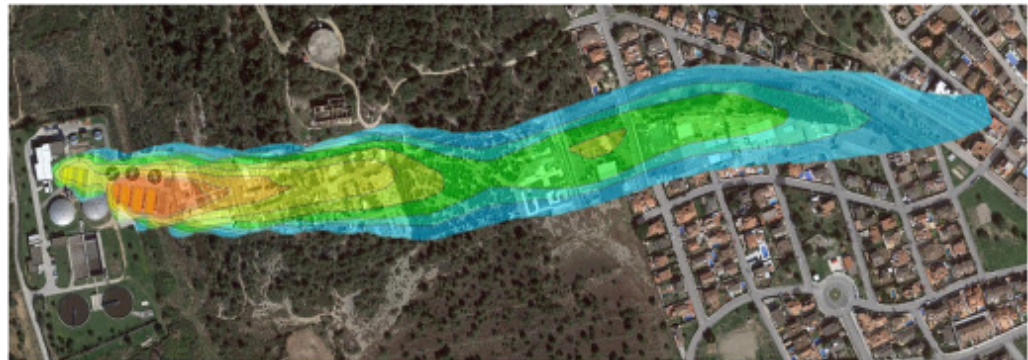

Limitations and future perspectives

- Limited operational capacity
 - Endurance
 - Autonomy
 - Flight range
 - Current regulations
- Limited payload capacity
 - Precludes more accurate chemical instruments to be used
- Downwash
 - It dificults the measurements distorting the concentration distribution
 - Smaller drones with lower total payloads



SNIFFIRDRONE project

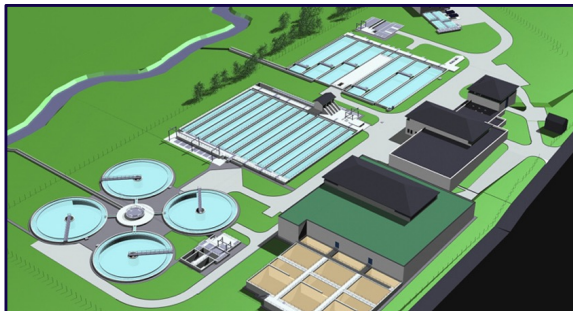

- European  ATTRACT project
- Previous phase 1 project
- 6 European Partners



We will build and demonstrate a drone-based system to monitor volatile chemicals and odours emitted by waste water treatment plants.

SNIFFIRDRONE objectives

- 1** Development of a high performance multi-gas NDIR sensing unit

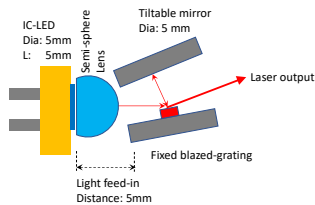

- 2** Multi-gas NDIR unit demonstration in relevant environment

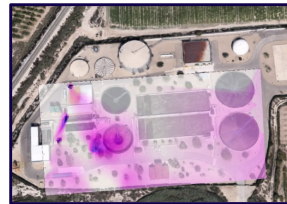

TRL 7

- 3** 3D mapping of waste water treatment plants emissions

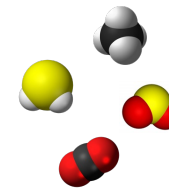

- 4** Estimation of odour perception from waste water treatment plant emissions

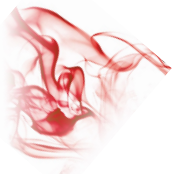

- 5** 3D mapping of odour perceptions in composting plants



- 6** Drone-based system demonstration in relevant environment



Drone-based sensing system

- DJI Matrice 600 drone

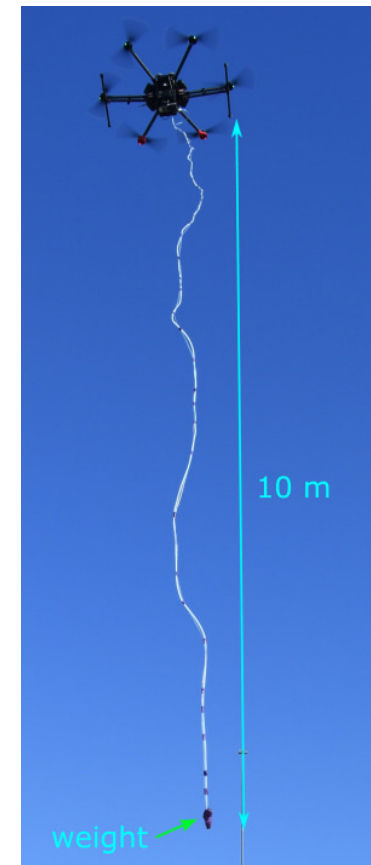

Drone-based sensing system



Custom IOMS

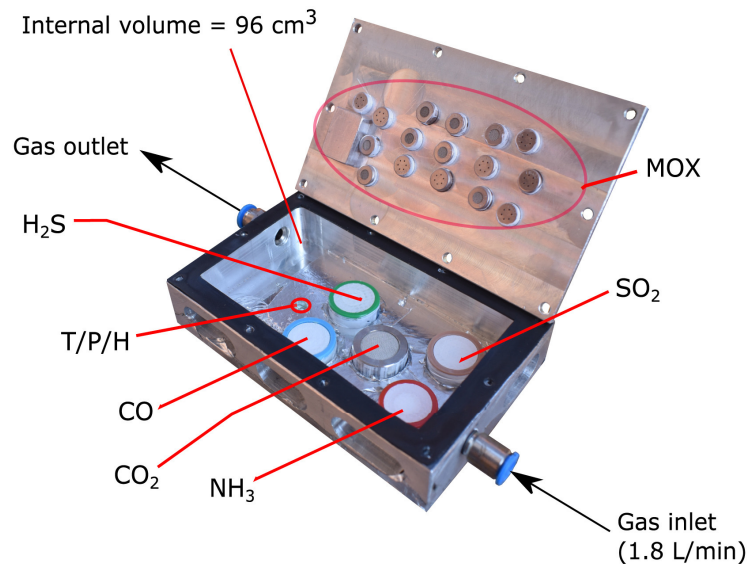

	Technology	Range
Temperature	Integrated	-40 to +85°C
Humidity	Integrated	0 to 100% RH
Pressure	Integrated	30 to 110 kPa
Flow rate	Ultrasonic	-33 to +33 L/min
CO ₂	NDIR	0 to 5000 ppm
CO	Electrochemical	0 to 100 ppm
H ₂ S	Electrochemical	0 to 20 ppm
NH ₃	Electrochemical	0 to 100 ppm
SO ₂	Electrochemical	0 to 20 ppm

Model	Target gases
TGS 2600	H ₂ , CO, Ethanol
TGS 2600	H ₂ , CO, Ethanol
TGS 2600	H ₂ , CO, Ethanol
TGS 2600	H ₂ , CO, Ethanol
TGS 2602	H ₂ S, NH ₃ , Toluene
TGS 2602	H ₂ S, NH ₃ , Toluene
TGS 2602	H ₂ S, NH ₃ , Toluene
TGS 2602	H ₂ S, NH ₃ , Toluene
TGS 2611	CH ₄ , Hydrocarbons
TGS 2611	CH ₄ , Hydrocarbons
TGS 2611	CH ₄ , Hydrocarbons
TGS 2611	CH ₄ , Hydrocarbons
TGS 2620	Alcohols, ketones
TGS 2620	Alcohols, ketones
TGS 2620	Alcohols, ketones
TGS 2620	Alcohols, ketones

[Burgués, et al. *iScience* 24(12), 2021]



Custom IOMS block diagram

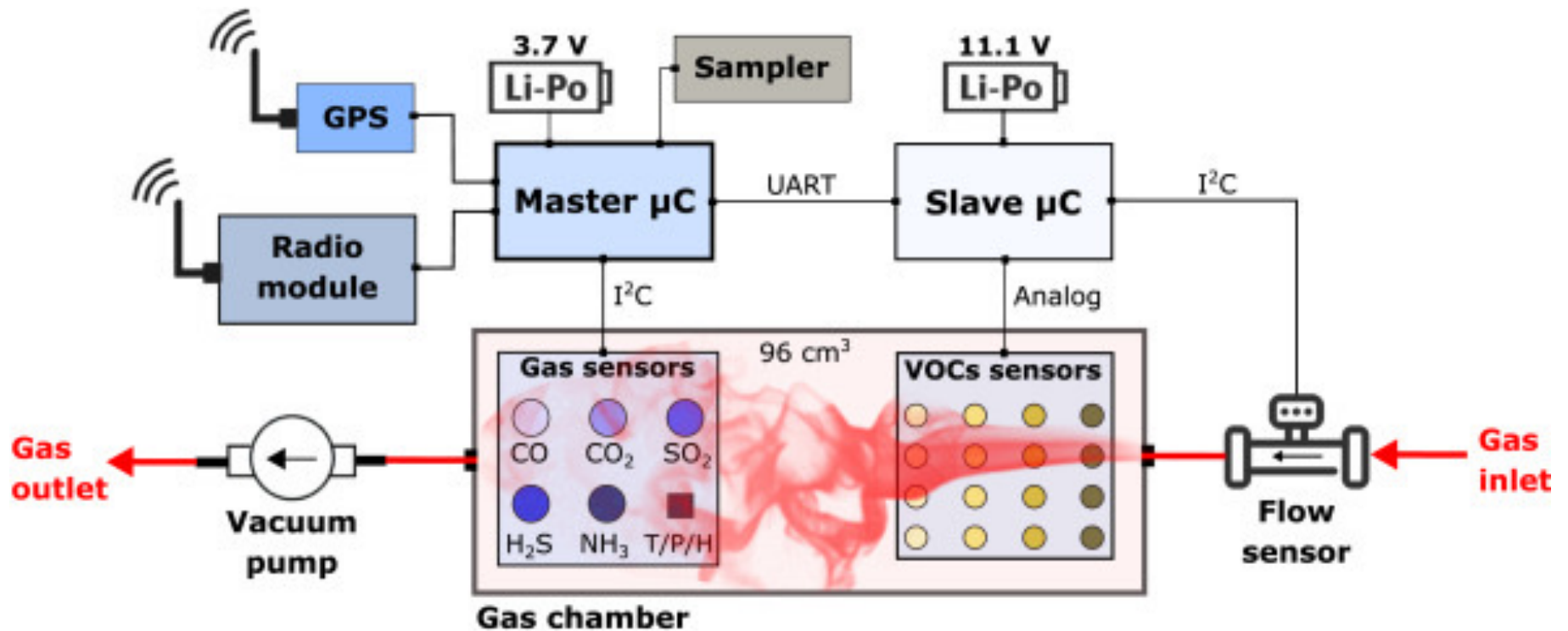

[Burgués, et al. *iScience* 24(12), 2021]

2nd version IOMS

Drone-based odour and pollution monitoring system



Near IR sensing unit (NH₃, CH₄)

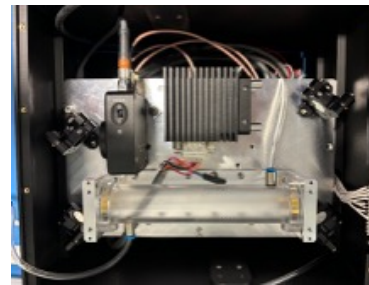

Mid IR sensing unit (CH₄, CO₂)

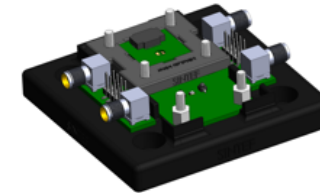





Base Station (on the ground)

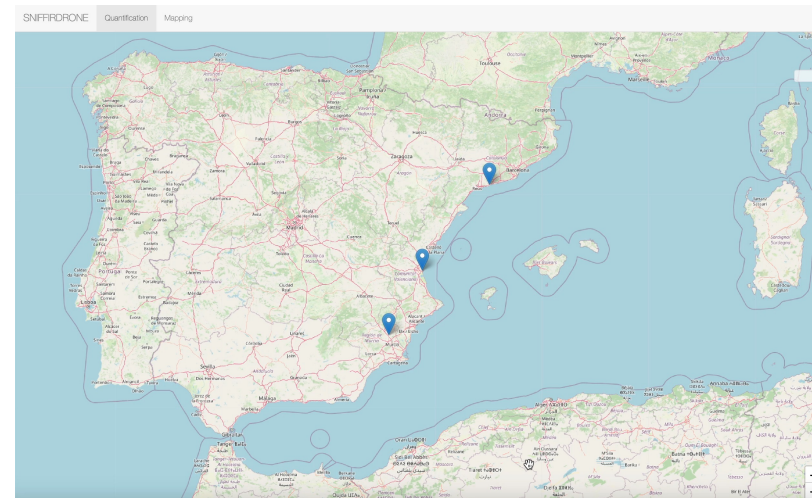

Chemical sensors array unit (and air sampler)



Improved sensor chamber

- Reduced size
 - 50x67x22 mm
- 4 digital MOX sensors
- 3 cavities
 - $5 \times 5 \times 4 \text{ mm} = 25 \text{ mm}^3$
 - ENS 160 
 - SGP 41 
 - BME 688 
- 1 larger cavity
 - $10 \times 10 \times 0,6 \text{ mm} = 60 \text{ mm}^3$
 - SCD41 

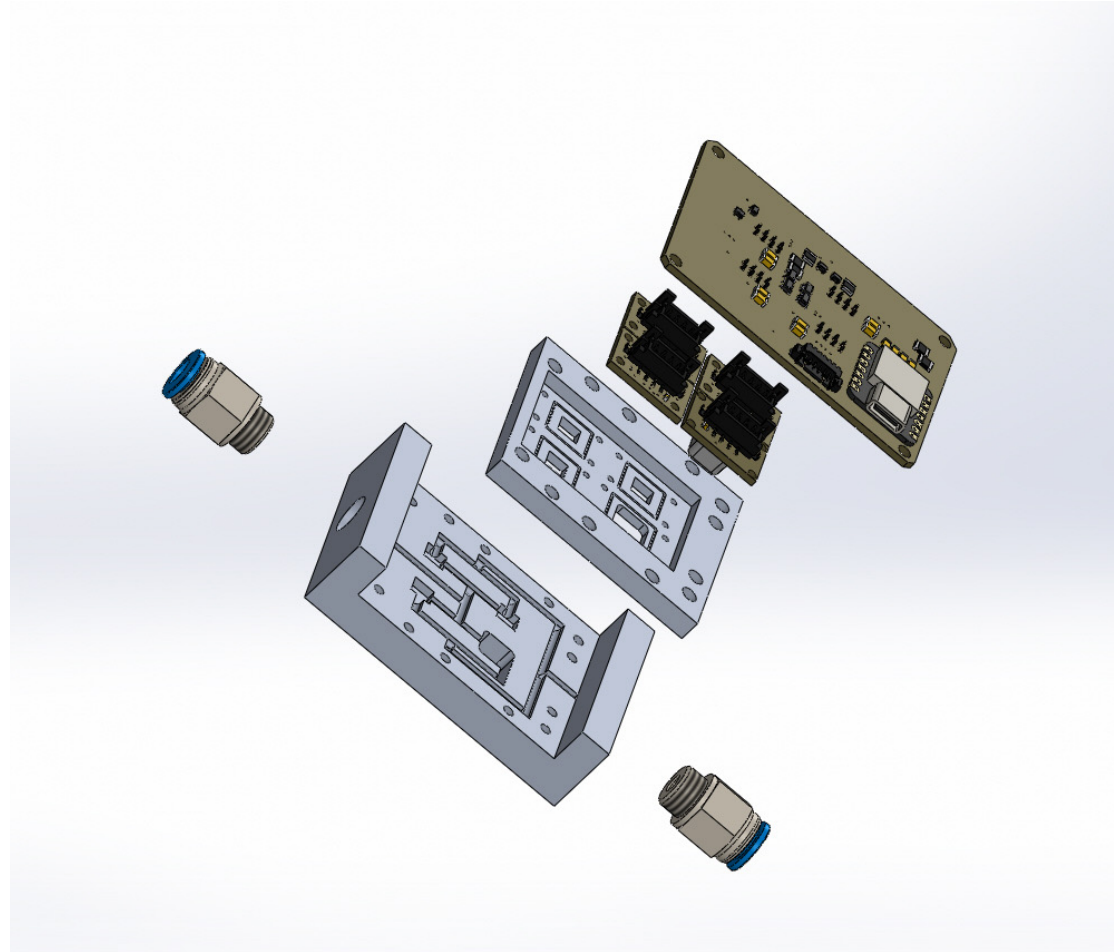

Air speed simulation within the chamber

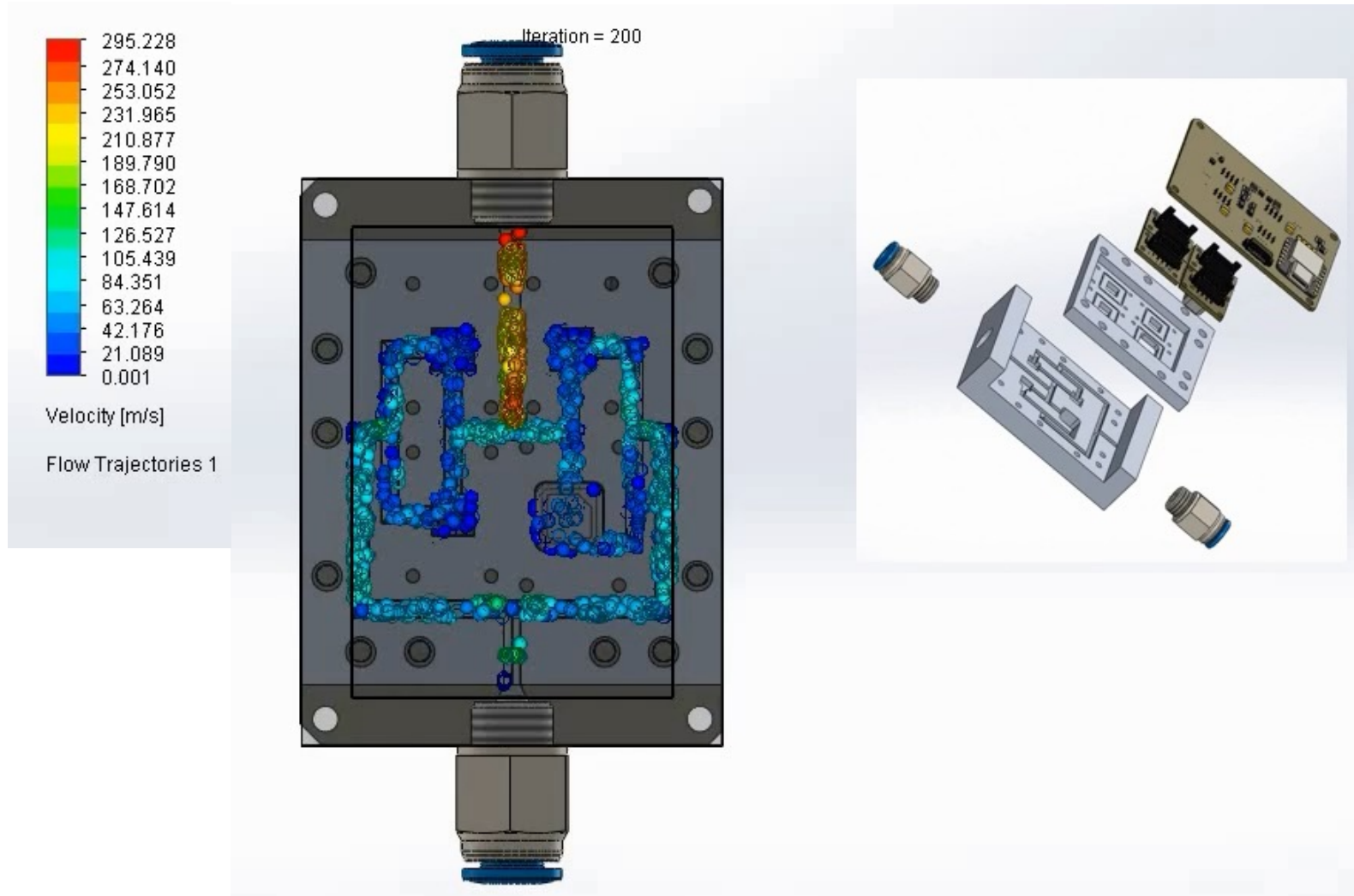

Odour prediction model

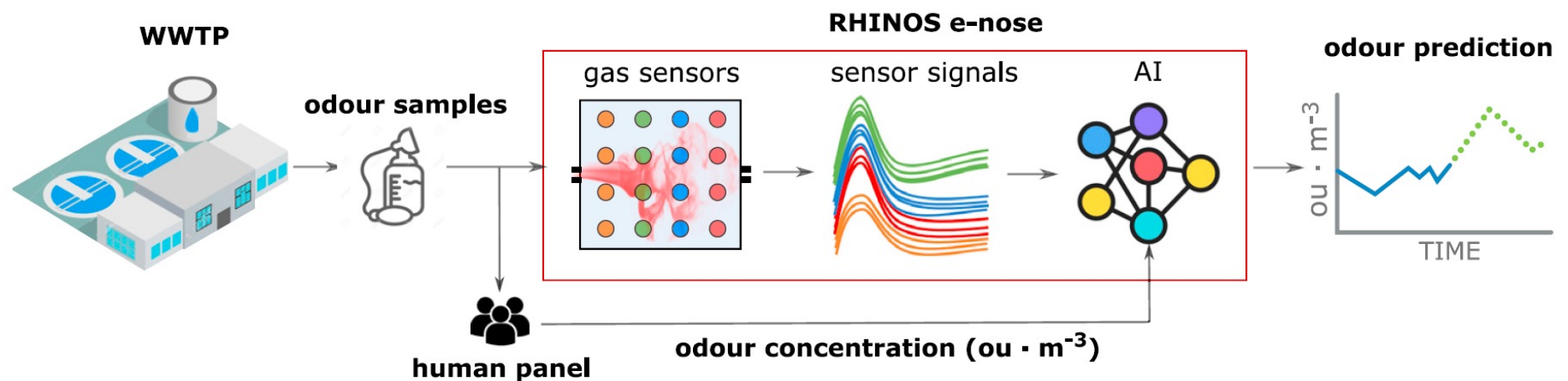

[Burgués, et al. *Science of The Total Environment* 846, 2022]

Molina de segura WWTP

- Medium size WWTP
- 35,000 m²
- Water origing
 - ▣ 70% Civil
 - ▣ 30% Industrial



Molina de segura WWTP

- Target areas
 - Settler
 - Bioreactor
 - Pretreatment
 - Chimney

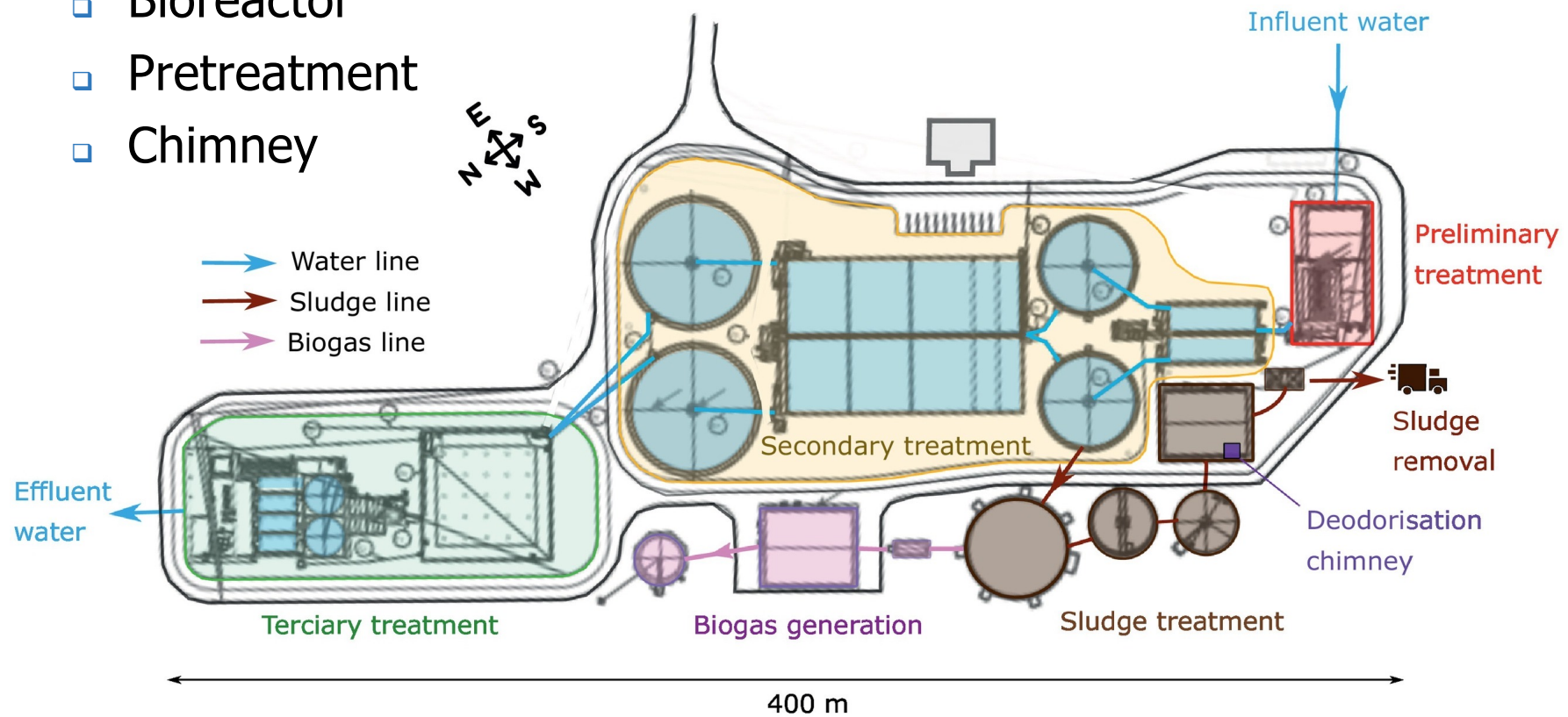

Campaigns and measurements

Day	Date	Settler	Bioreactor	Pretreatment	Chimney	Total (odour)	Blanks	Total
1	24/06/2020	3	3	2	2	10	7	17
2	25/06/2020	2	2	2	2	8	6	14
3	14/07/2020	3	3	3	3	12	11	23
4	15/07/2020	3	3	3	3	12	7	19
Total		11	11	10	10	42	31	73



Measurement procedure

- 5 minutes measurement per sample/source
 - 45 data points in 5 minutes
- 1 minute filling sampling bag

Chimney – 2 meters

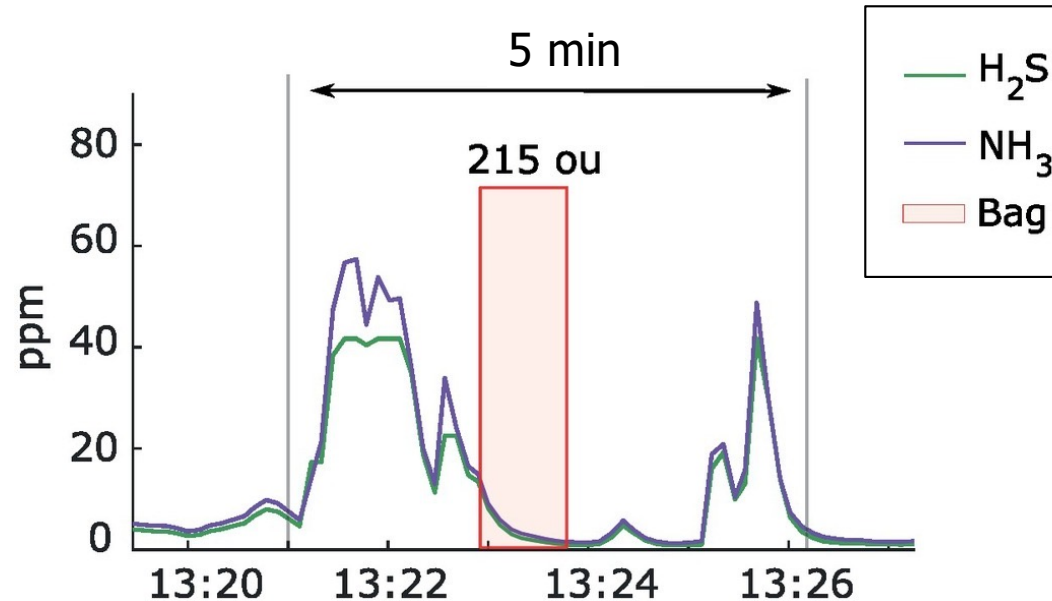

Resulting feature matrix

- $X : 73$ (samples) \times 945 (features) $y : 73 \times 1$
 - $n : 73$
 - $m : 975 = 21$ (sensors) \times 45 (samples/sensor)

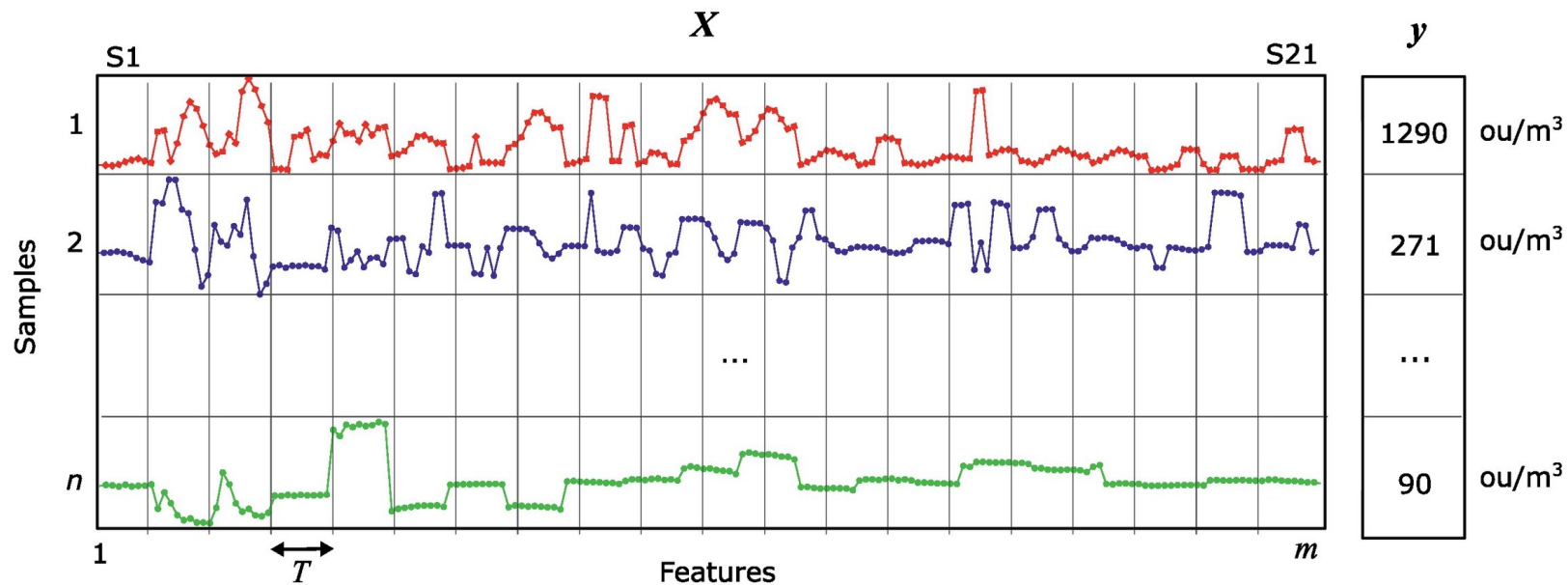

Sensor responses first day

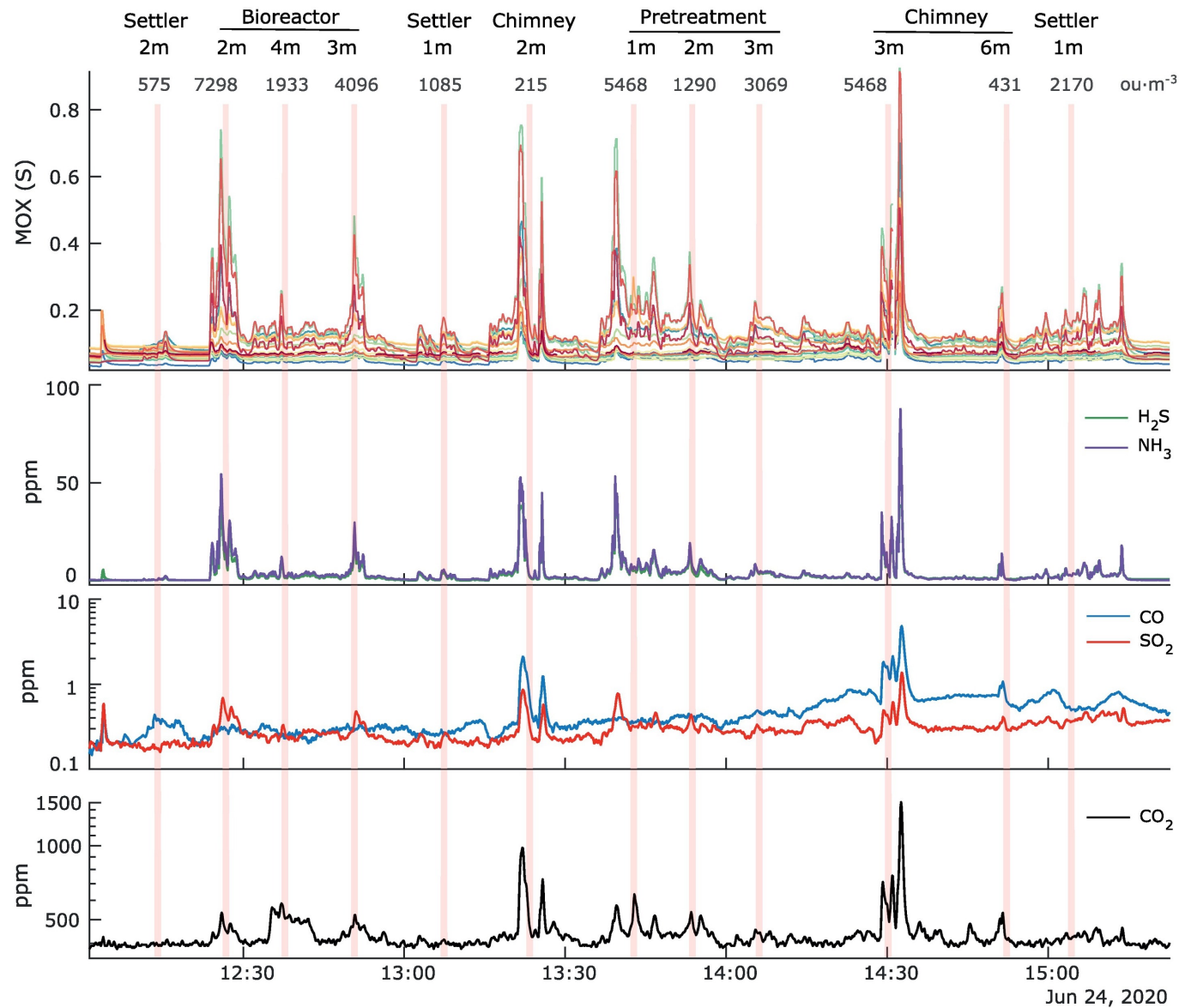

Decay gas and odour concentration with height

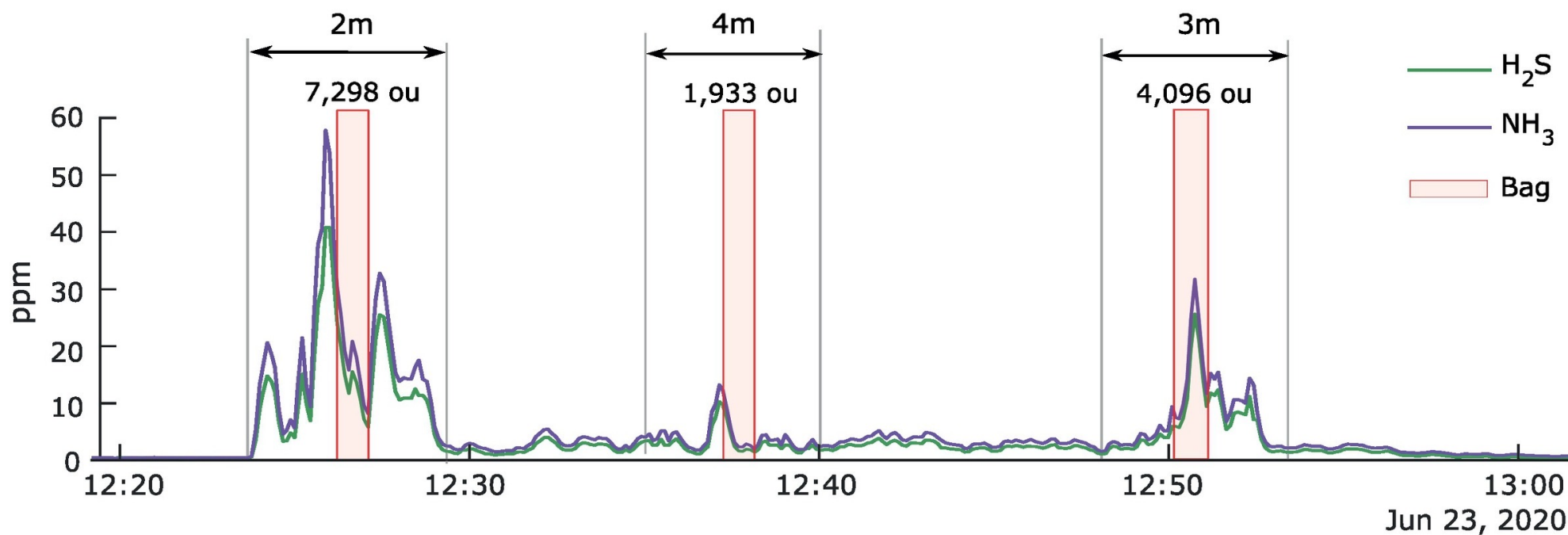

Ferature extraction requiered

- Sensor response of first three days of measurement
- Colored by odour concentration

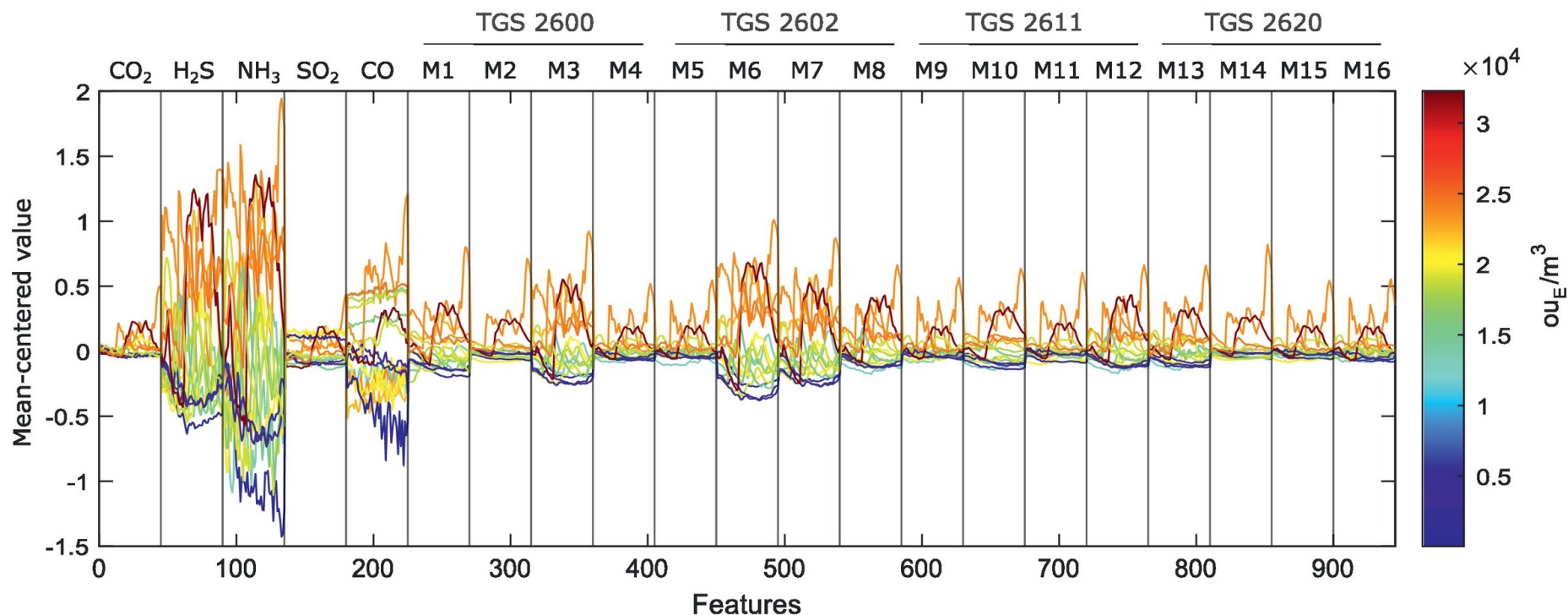

Feature extraction with VIPs

- Variable importance in projection (VIP) scores as a function of the
- 5 sensors (a), (b), (c), (d), and (e) are selected – **VIP > 1**
- Optimum window delayed 30s from air sampling window

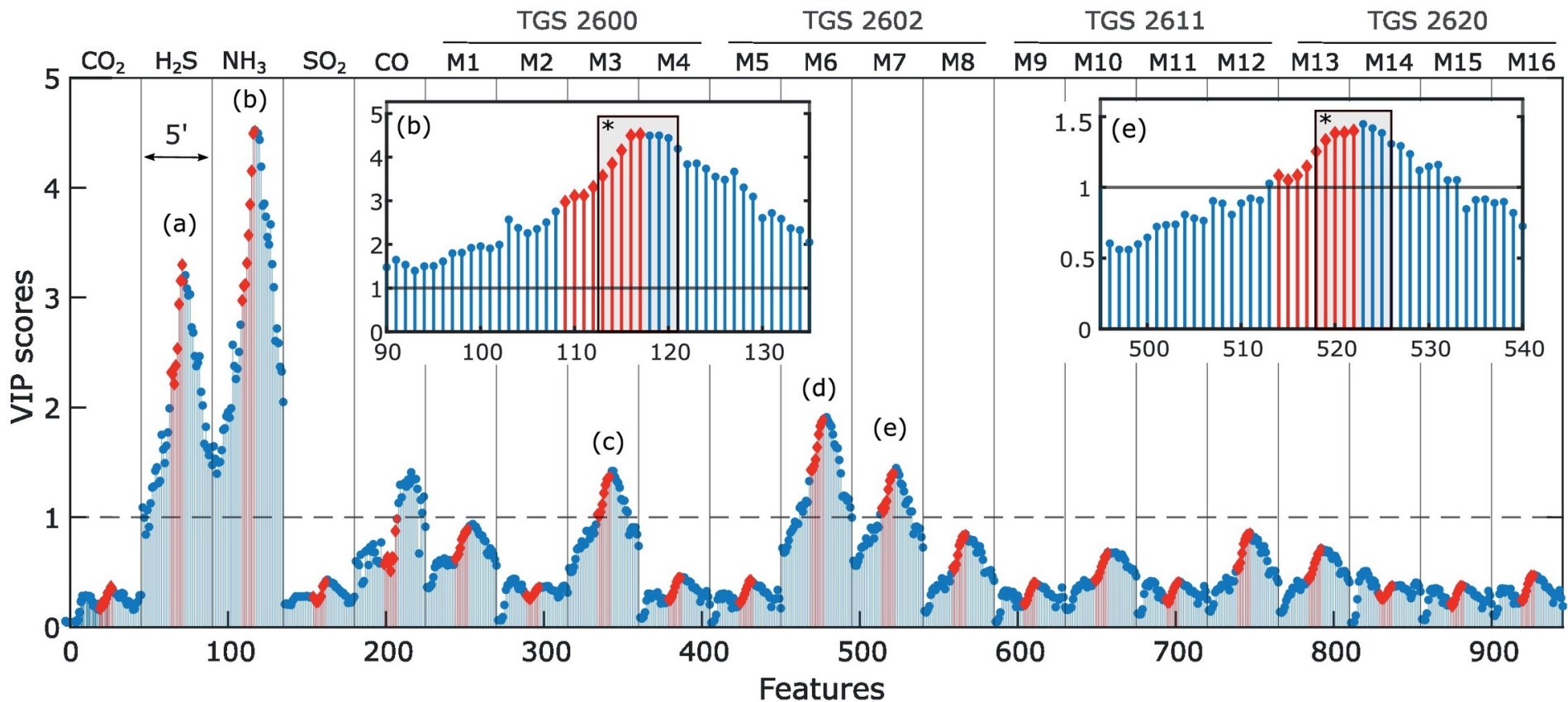

Cross-validation of PLS models

External validation

Model	Day 1	Day 2	Day 3	Day 4
Model 1 (β_1, LV_1)	X	C	C	C
Model 2 (β_2, LV_2)	C	X	C	C
Model 3 (β_3, LV_3)	C	C	X	C
Model 4 (β_4, LV_4)	C	C	C	X

Internal validation model 1

Iteration	Day 2				Day 3				Day 4			
	S	B	P	C	S	B	P	C	S	B	P	C
1	V	T	T	T	T	T	T	T	T	T	T	T
2	T	V	T	T	T	T	T	T	T	T	T	T
3	T	T	V	T	T	T	T	T	T	T	T	T
...
N	T	T	T	T	T	T	T	T	T	T	T	V

Prediction results of PLS model

- Four emission sources predicted with similar errors
- Negligible bias between predicted and real values
- Limits of agreement (LoA) [$0.25 \times$, $3.91 \times$]

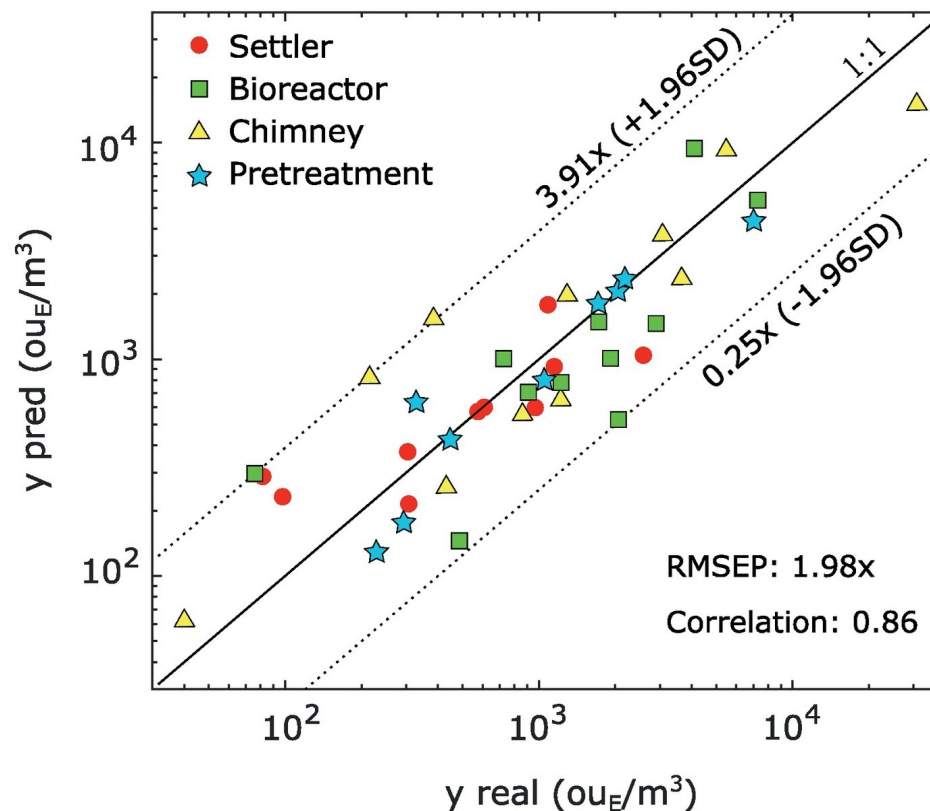

Static vs. Dynamic calibration

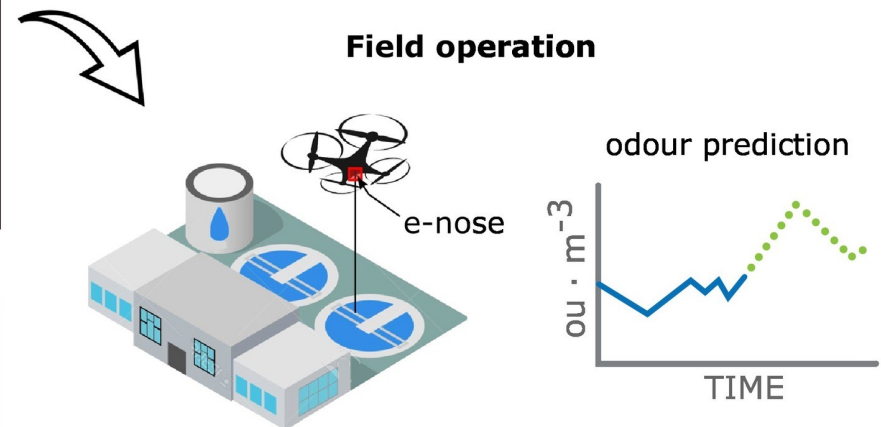
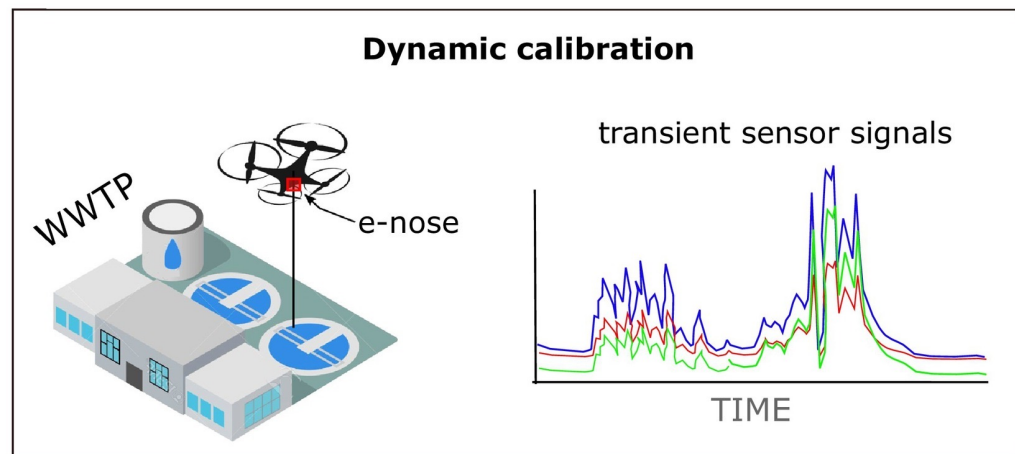
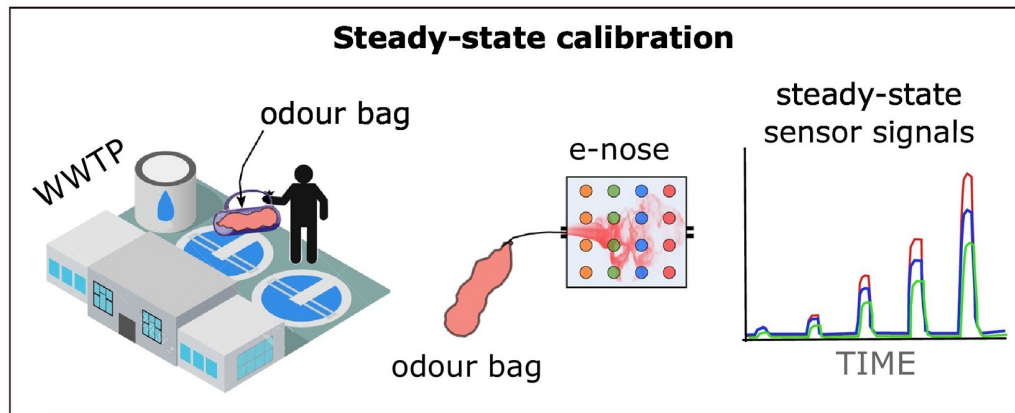

Static vs. Dynamic calibration

	RHINOS (Burgués et al., 2021a)		SNIFFDRONE
Calibration	Lab (odour bags)	Lab (odour bags)	Field (drone)
Validation	Lab (odour bags)	Field (drone)	Field (drone)
RMSEP	1.8×	2.46×	1.98×
Correlation	0.97	0.75	0.86
Bias	0	0.01	0.01
LoA	[0.41×, 1.97×]	[0.17×, 6.10×].	[0.25×, 3.91×].



Odour map

- Specific drone path to cover the WWTP
 - Drone speed was set to ~ 0.5 m/s
 - 225 measurement points (25 min flight \times 9 samples/min)
 - Area 200×100 m²
 - Spatial resolution of 3 m (0.5 m/s \times 6 s/sample)

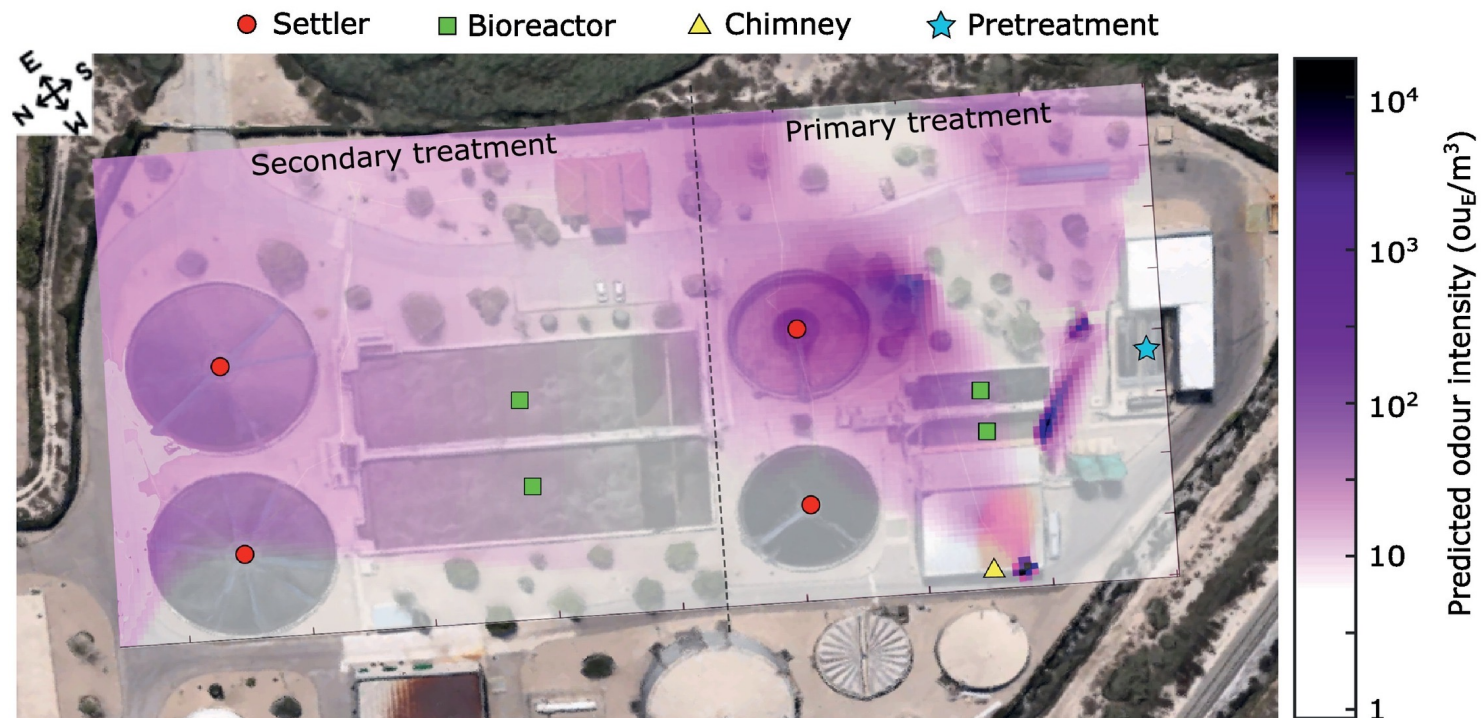

Conclusions

- There are still a number of challenges in front of us to improve environmental monitoring with drones
- The results show that dynamic calibration can substitute static calibration
- Environmental monitoring in industrial plants with drones can be an alternative to olfactometries
- The approach will benefit from a larger dataset with more campaigns

